

Roller Shade

Installation and Troubleshooting Instructions



Questions? We can help! Call Vista's Hot Line for quick assistance. 1-800-726-3380
If you are missing parts or have questions about the operation of your blind, call our Hotline. Please have the Vista order number available, it can be found printed on a sticker affixed to the headrail or shipping label.

To install your Vista shades, you will need a few basic tools: pencil, level, drill and drill bits, measuring tape, and screwdriver. Before you begin, please read the instructions all the way through to acquaint yourself with the recommended procedures.

Installing Shades With Valances

Installing an Inside Mount Square Corner Valance
(skip this section if valance not ordered)

1. Locate the valance for the shade being installed.
2. The square corner valance is designed so that the face will extend beyond the window opening on each side. The dust cover is cut out on each end to allow the valance to protrude into the window opening at the desired depth. Position the valance so that it is square to the wall and install the valance with screws provided.

Installing an Outside Mount Square Corner Valance
(skip this section if valance not ordered)

1. Locate the valance for the shade being installed.
2. The valance dust cover has been pre-punched with slots for installation. Center the valance on the window opening and mark (with a pencil) the location of each slot. These marks are where each wall bracket should be installed.
3. Once wall brackets are installed, assemble nut and bolt through valance dust cover and bracket.

Square Corner Valance Returns

Insert valance returns into the narrow slot of the corner joint. Trim return to desired length with heavy duty shears. Insert valance face into the wide slot of corner joint.

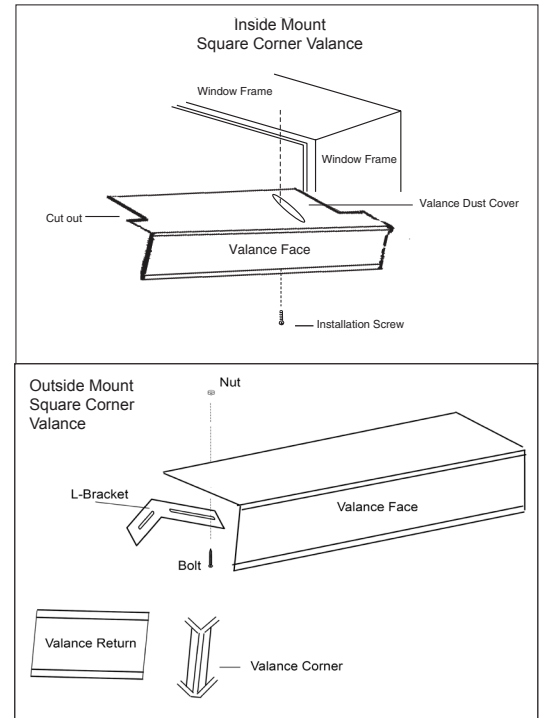

Installing an Inside Mount Faux Wood Crown Valance
(skip this section if valance not ordered)

1. Locate the valance and valance brackets for the shade being installed.
2. The faux wood crown valance is designed so that the face will recess into the window opening. A minimum depth of 3 1/2" is required for inside or flush mount. If mounting depth is less than 4 1/2", you must cut 1" off the back of the bracket, cut between the 2 screw slots.
3. Before installing, check to make sure you have enough clearance for the shade to be mounted. If there is not enough space, you may need to specify an outside mount valance with a small return to cover the gap.
4. The valance brackets have been pre-punched with slots for installation. Mark (with a pencil) the location of each slot in the window opening. Install the brackets.
5. Once the shade is installed the valance snaps into the valance clips.

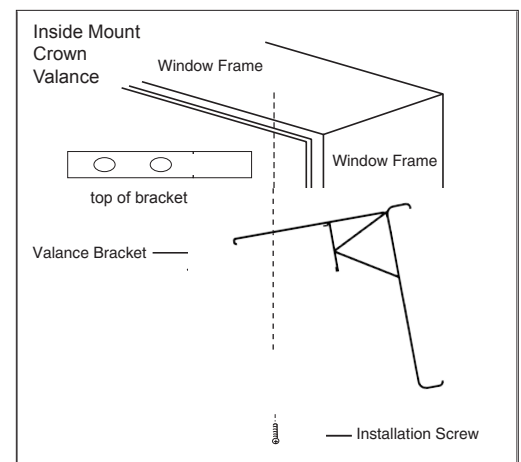

Installing an Outside Mount Faux Wood Crown Valance
(skip this section if valance not ordered)

1. Locate the valance and valance brackets for the shade being installed.
2. Install the wall brackets with the screws provided.
3. Once wall brackets are installed, assemble nut and bolt through the valance bracket as shown.
4. Insert the valance corner bracket into the slot on back of valance and valance return and press together to form corner.
5. Once the shade is installed the valance snaps into the valance clips.

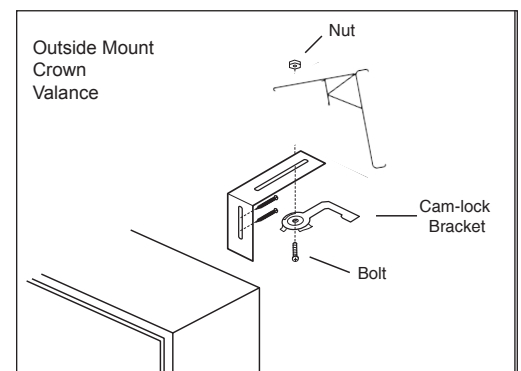

Roller Shade

Spring Roller Installation Instructions



STOP! Check the top of window opening with a level; most windows, ceilings, and floors are not truly level.
Roller shade brackets must be LEVEL for the shade to operate properly.
 To ensure your shade is mounted level, do not measure down from the ceiling or up from the window sill.
 Determine where and how the shade will be mounted and follow the steps below.

Positioning the Brackets:

Standard Roll (Fabric falls from the back of the shade.) The slotted bracket is mounted on the left side.
 Reverse Roll (Fabric falls from the front of the shade.) The slotted bracket is mounted on the right side.

Inside (Fig. 1) or Ceiling (Fig. 2) Mount:

1. Determine if the window opening or ceiling has a high and a low side when checked with a level.
2. Mount the first bracket (either spring 'slotted' or idle 'pin' end) on the low side of the window opening, remembering to allow room so the top of the roll does not rub against the window opening. (Inside Mount Only)
3. Next place the loose bracket onto the opposite end of the roller and hold in position while inserting the first end into the mounted bracket.
4. While holding the shade in place, adjust the position of the roller until level (center the bubble) and mark the bracket location. Shims may be needed for ceiling mounted shades to make the brackets level.
5. Remove shade, install the bracket and hang the shade. The shade should now be level in the opening.

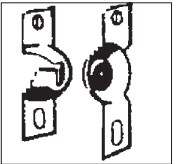
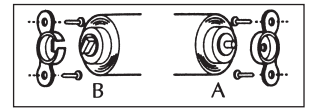

Fig 1



Inside Mount

to the inside of the window frame

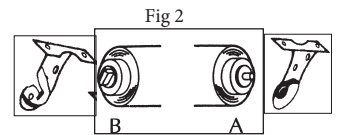

Fig 2

Ceiling Mount

to the ceiling or to the top of the window frame

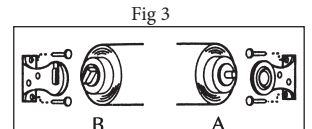

Fig 3

Outside Mount

to the wall or to the front of the window molding

Outside Mount:

1. Mount the first bracket (either spring or idle end) at the desired height.
2. Repeat steps 3 thru 5 above. The shade should now be level on the window.

Spring Roller Shades Troubleshooting

Problem:	Check:	Solution:
Shade will not up all the way	Tension on the roller	Adjust the tension on the roller

Adjusting Tension on the Spring Roller:

1. If you desire more tension, pull the shade down half way and remove from brackets. (Fig A)
 2. Roll shade up by hand. (Fig B)
 3. Replace the shade in the brackets.
- If you have too much tension, remove the shade from the brackets while it is completely rolled up and unroll half way down by hand. Replace the shade in the brackets.
- NOTE: Too much tension may damage the roller.

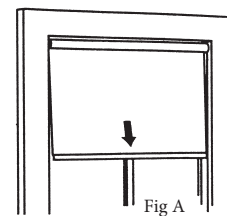

Fig A

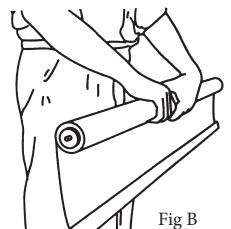

Fig B

Problem:	Check:	Solution:
Shade goes up crooked	Make sure you are pulling the shade from the center of the hem. If you pull the shade from one side, it will cause the fabric to roll up crooked.	Pull shade from center of hem.

Are your brackets level? Brackets must be level for the shade to operate properly.

Use a level on top of the roller to test and adjust brackets accordingly. Try using "Leveling Tape".

Which side is the fabric coning on? (side the fabric is rolling toward the bracket)

When the shade is in the up position please note the side that the fabric is moving towards the wall. Slowly lower the shade until a small portion of the roller is exposed. Place a piece of the leveling tape on the opposite side of the roller. Repeat process by adding tape until the shade straightens.

Still have questions? Call our hotline at 1-800-726-3380

Motorization: (Changing the Pre Set Height Limits)

- Step 1. Send the shade to its current upper / lower limit.
- Step 2. Press both UP and DOWN on the remote control at the same time until the shade jogs.
 Adjust one position at a time.
 Adjust to a new lower limit position by using DOWN. Adjust to a new upper limit position by using UP.
- Step 3. Press (MY) until the shade jogs. Repeat to adjust other limits.



Roller Shade

Clutch Roller Installation Instructions



STOP! Check the top of window opening with a level; most windows, ceilings, and floors are not truly level. **Roller shade brackets must be LEVEL for the shade to operate properly.** To ensure your shade is mounted level, do not measure down from the ceiling or up from the window sill. Determine where and how the shade will be mounted and follow the steps below.

Positioning the Brackets:

If the clutch is on the right end of the shade, the clutch (blade) bracket is mounted on the right side while the "V" bracket is mounted on the left. If the clutch is on the left end of the shade, the brackets are reversed. (See diagram below.)

Inside (Fig. 1) or Ceiling (Fig. 2) Mount:

1. Determine if the window opening or ceiling has a high and a low side when checked with a level.
2. Mount the first bracket (either clutch 'blade' or idle 'V' end) on the low side of the window opening, remembering to allow room so the top of the roll does not rub against the window opening (inside mount only).
3. Next place the loose bracket onto the opposite end of the roller and hold in position while inserting the first end onto the mounted bracket.
4. While holding the shade in place, adjust the position of the roller until level (center the bubble) and mark the bracket location. Shims may be needed for ceiling mounted shades to make the brackets level.
5. Remove shade, install the bracket and hang the shade. The shade should now be level in the opening.

Outside Mount (Fig. 3):

1. Mount the first bracket (either clutch 'blade' or idle end) at the desired height.
2. Repeat steps 3 thru 5 above. The shade should now be level on the window.

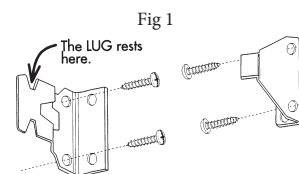
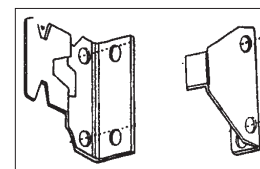
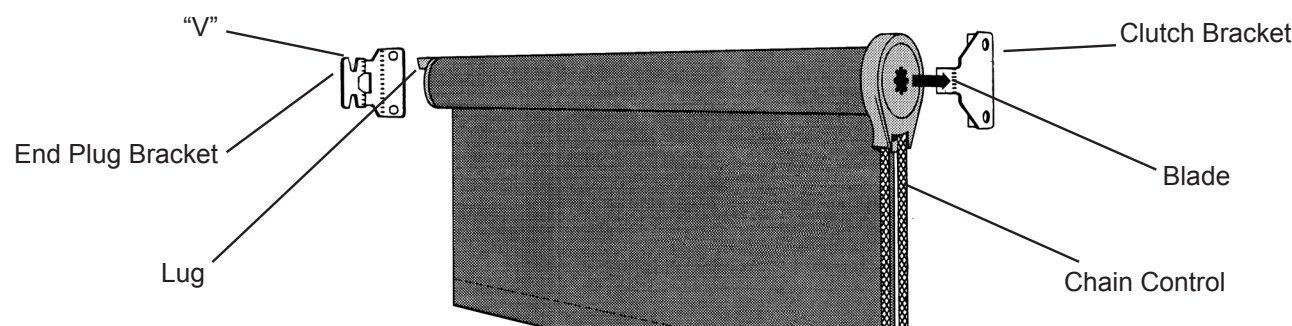

Inside Mount to the inside of the window frame

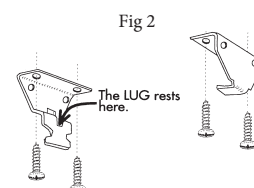

Ceiling Mount to the ceiling or to the top of the window frame

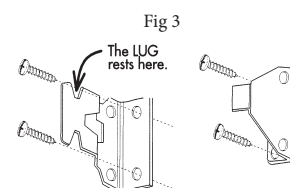

Outside Mount to the wall or to the front of the window molding

Install the shade:

1. Push the clutch straight onto the blade of its bracket. The bottom of the clutch should always point straight down.
2. Lower the lug of the end plug onto the "V" of its bracket. The roller should fit in the brackets securely, with just a little play.
3. There are 2 connectors/stopballs for all roller shade control loops. The connector/stopball at the back of the shade will be a stop for the top of the shade while the one at the front will be set for the bottom of the shade. This stopball will be set one inch longer than the shade ordered height to prevent the shade from being over rotated. This connector can be moved to any desired location.

ALL Clutch Roller Shades

Install Tension Device:

1. ANSI (American National Standards Institute) regulations require any cord or chain loop be secured to the wall to reduce the risk of possible injury to young children. To comply, this device must be used at time of installation.



Clutch Roller Shades Troubleshooting

Problem:	Check:	Solution:
Clutch chain connector is stopping chain from rotating	Chain connector	Pull the shade to the "open" position and remove the shade from the brackets. Roll the fabric up by hand and replace the shade into the brackets. (See Fig A and B under Spring Roller Troubleshooting)

Still have questions? Call our hotline at 1-800-726-3380

Roller Shade

Clutch Roller Installation Instructions



IMPORTANT! Roller shade brackets must be LEVEL for the shade to operate properly.

Cassette Headrail:

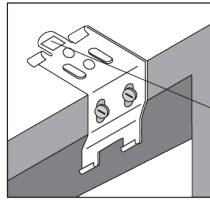

For WALL or OUTSIDE mounts, use the rear bracket holes. Make sure the release tab is always mounted on the top.

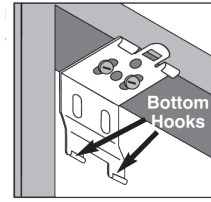

For INSIDE or CEILING mounts, use the top bracket holes. Make sure the release tab is always mounted on the top.

Mount the headrail.

Position the headrail with the back panel (A) resting on both bottom hooks of all the brackets. Push the front of the headrail firmly upwards and toward the window until the groove at the top of the headrail snaps into place (B) as shown.

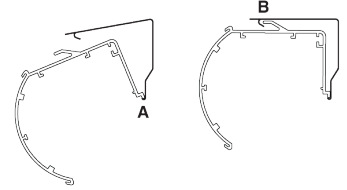

Square or Curved Fascia:



Mount the Brackets:

1. The open end of each bracket faces downward.
 Note: If you have an inside mount and must use "end mount holes", you will have to drill your own holes in the side of the bracket. Use at least two screws per brackets, and make sure that the screw heads clear the clutch mechanism. Install the brackets.

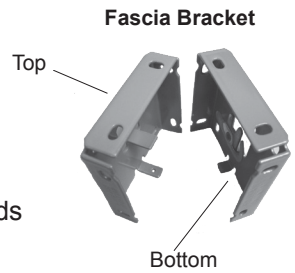

2. Slide the clutch straight onto the blade of the bracket. The foot must go through the narrow opening between the bottom of the clutch and the top of the chain guard. The bottom of the clutch should always point straight down as shown below. Lower the lug of the end plug into the "V" of its bracket. Helpful Hint: Unroll the shade part way (using chain control) prior to placing into the lug "V" bracket. The roller should fit in the brackets securely, with just a little play. Rotate the swivel arm to secure in place.

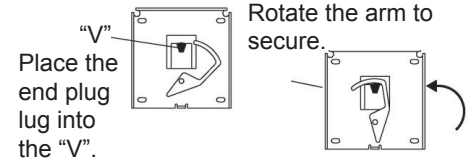
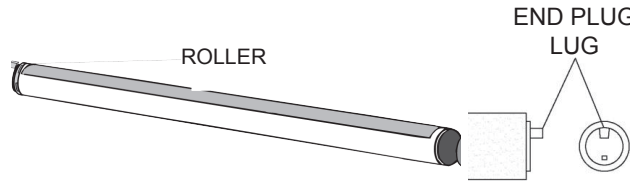
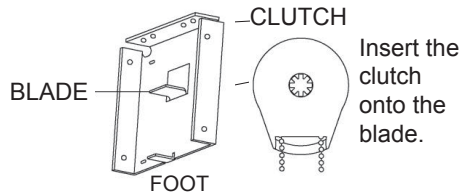

3. After the shade is installed, place the top lip of the fascia panel on the opening of the brackets. Rotate downward and push on the bottom of the fascia until hear a snap.

4. Bracket covers (returns) are provided ONLY for the curved and wrapped fascia panels. Place the spring clip into the inside curve of the fascia. Pull the cover towards the room and slide the edge of the cover over the fascia. If needed, trim bracket cover to desired length with heavy duty shears.

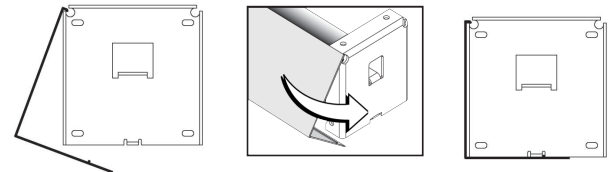

Magic Lift Headrail System: (Follow Cassette Headrail Instructions for Magic Lift Shades with Cassette)

Install the appropriate number of brackets. The clear tension tab should be placed to the top for outside mount and to the front for inside mount. This allows for easy removal of the shade.



Place the bottom of the headrail into the bottom rear of the bracket then gently push shade up to snap into the headrail.

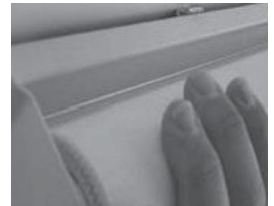

Adjust the tension:

Tension adjustments may be made by using a standard screwdriver with the side-adjust bracket.

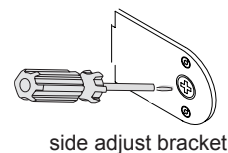

Multiple shades mounted side-by-side may not "stop" at the exact same height when installed. However, "stop" adjustments can be made. Set the Stop Device to the desired stop position by using a standard screwdriver with the side-adjust bracket.

Inside mount shades must be uninstalled to make adjustments. To add tension, turn counter clockwise. To reduce tension, turn clockwise.

NOTE: Cordless shades should be installed on windows where the consumer can comfortably reach the shade hem or decorative cord pull to raise and lower.

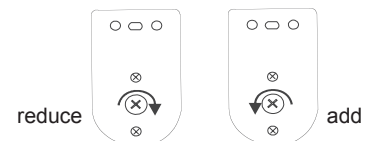

Still have questions? Call our hotline at 1-800-726-3380