

# INSTALLATION INSTRUCTIONS – ROLLER SHADES

## Tools Required:

Tape measure, pencil, drill, drill bits, screw driver, step stool or ladder.

*Note: use a 5/64" drill bit to pre-drill the screw holes (for attachment to a wall stud or header board). Use Wall Anchors (not included) for hollow dry wall or plaster mounting.*

## Step 1. Mount the Brackets

attach the brackets to the window frame, molding or ceiling as shown. The brackets are "universal" – there are no "right" and "left" brackets. Mark the screw locations with a pencil – pre-drill the screw holes using a 5/64" drill bit.

## Step 2. Install the Shade

Put the spring loaded pin into the round hole of the bracket, push the spring loaded tip into the bracket, and then insert the hook arms on the opposite side of the shade into the two hook arm receiver holes of the bracket. Once the two hook arms are through the holes, gently pull down until the two hook arms have locked securely to the bracket. For cord control shades, the bottom of the clutch should always point straight down.

## Step 3. Install the Bracket Covers

– For Outside Mount Shades Only!

Bracket covers slide onto the brackets as shown until they snap into position.

## Step 4. Install the Chain Tension Device

The tension device must be installed to make sure the shade is fully operable.

Before doing anything, you must first slide the tension device to the bottom of the bead chain.

While holding the tension device in one hand, pull the plunger away from the bead chain with the other hand. Lift the bead chain out of the bead locking groove and slide the tension device to the bottom of the chain loop.

Pull the tension device down until the bead chain is fully tensioned (plunger will be at the top) and then move the tension device up approximately 1/8".

Mark the screw hole locations on the wall with a pencil.

**Inside Mount:** if mounting into wood, pre-drill screw holes and then install the tension device using the 1 1/4" Phillips head screws provided.

If not securing into wood, use appropriate anchors for the substrate and follow anchor manufacturer's instructions.

**Outside Mount:** Align the mounting bracket screw holes with the pencil marks.

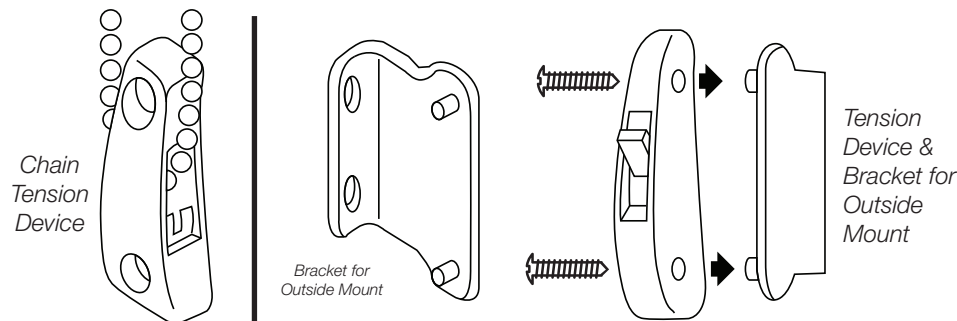
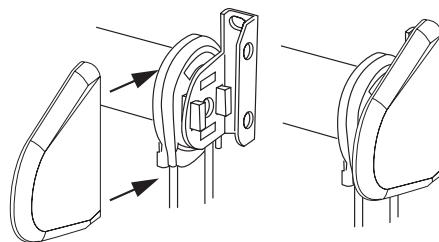
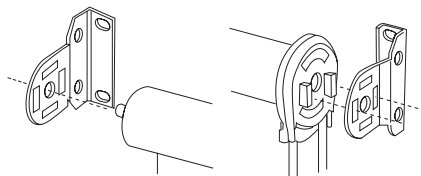
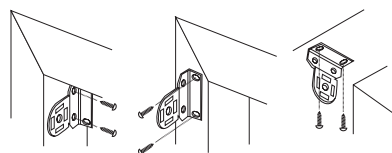
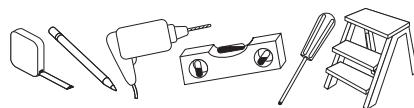

If mounting into wood, pre-drill screw holes and then install the mounting bracket using the 1 1/4" Phillips head screws provided.

If not securing into wood, use appropriate anchors for the substrate and follow manufacturer's instructions.

Press the tension device onto the mounting bracket posts. Carefully attach the Tension Device to the bracket using the 3/8" Phillips head screws provided. **DO NOT OVER-TIGHTEN.**

## Step 5. Operating the Shade

Pulling gently on the cord in one direction raises the shade; pulling it in the other direction lowers it. On shades where the fabric rolls against the window, the front cord lifts the shade. On shades where the fabric rolls toward the room, the rear cord lifts the shade.

## Step 6. Hold Down Brackets for Outdoor Shades

The elastic straps on each side of the bottom rail loop onto the open 'C' section of the hold down brackets as illustrated. Attach the hold down brackets to a wall, post or other solid surface. Use 1" screws (or screws and anchors) to attach the brackets. Put tension on the straps by stretching them when positioning the brackets

## Cleaning the Shades

Dusting: Vacuum using the soft brush attachment. Washing: Use a cloth, sponge or soft brush and a mild detergent. Use warm or cold water, not hot water. Place toweling on the floor or window sill and wash the blind in sections.

## REPLACEMENT PARTS

In the event that replacement parts are ever needed, you may call: 1-800-264-1190.

Please be sure to provide the following information, if possible:

- The complete model or catalog number of your product
- A description of the product
- A description of the part needed

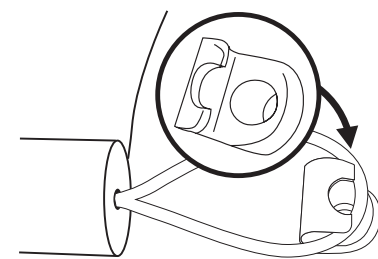

# INSTALLATION INSTRUCTIONS – ROLLER SHADES

## LIMITED LIFETIME WARRANTY

The enclosed product is warranted to the original residential retail purchaser as long as the product remains in the original window.

### Covered

**Lifetime:** Entire product against manufacturing defects (i.e. a flaw in the product design, materials, or workmanship that causes the product to no longer function).

**3 Years:** Cords, including internal cords such as those found in cordless blinds or shades.

**5 Years:** All fabric

### Not Covered

1. Normal wear and Tear

2. Any product that fails due to:

- Abuse
- Exposure to salt air
- Improper installation
- Accident
- Extraordinary use
- Improper operation
- Alterations
- Improper cleaning
- Misapplication
- Damage from pests/insects/pets
- Improper handling
- Misuse

3. Natural Wood Products that have:

- Loss of color intensity
- Variations in color, grain or texture
- Warping of wood slats in high humidity areas

4. Costs associated with:

- Product removal
- Brand label removal
- Product reinstallation
- Incidental or consequential damages
- Transportation to and from the retailer
- Product re-measure
- Shipping

In the event there are multiple blinds/shades in the same room, only the defective blind/shade will be replaced

### To Report Shipping Damage:

If damage occurred during shipping, call the place of purchase and report within 7 calendar days, or you may be denied credit for your damaged product.

### To Obtain Service:

If you suspect this product has a manufacturing defect in materials or workmanship:

- Locate the sales receipt
- Call place of purchase

Any unauthorized returns will not be accepted.

### Warranty Remedy:

This shall be your sole remedy under this limited warranty.

If this product is found to have a manufacturing defect in materials or workmanship, we will, at our discretion, do one of the following:

- Repair the product
- Replace the product
- Refund the cost of the product

Colors may vary from lot to lot and may not exactly match sample swatches or previous purchases. Discontinued items or color selections will be replaced with the closest equivalent current product.

**Your rights under state law:** This lifetime limited warranty gives you specific legal rights, and you may have other rights which vary from state to state. Some states do not allow limitations on how long a warranty lasts, so the above limitations may not apply to you. No agent, representative, dealer or unauthorized employee has the authority to increase or alter the obligation of this warranty. This lifetime limited warranty supersedes any previous versions.

## ! WARNING

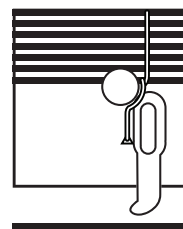

Window Blind Cord Can **STRANGLE** Your Child

- Children can climb furniture to reach cords.
- Move crib and furniture away.
- Keep all cords out of children's reach.
- Attach tension device to wall or floor.
- Fasteners provided with tension device may not be appropriate for all mounting surfaces.
- Use appropriate anchors for the mounting surface conditions.

## ! ADVERTENCIA

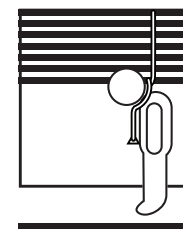

La cuerda ciega del a ventana puede **ESTRANGULAR** su niño

- Los niños pueden subir los muebles para alcanzar las cuerdas.
- Mueva la cuna y los muebles.
- mantenga todas las cuerdas fuera del alcance de los niños.
- Conecte el dispositivo de tensión a la pared o suelo.
- Los sujetadores provistos con el dispositivo de tensión pueden no ser apropiados para todas las superficies de montaje.
- Utilice anclajes apropiados para las condiciones de la superficie de montaje.